

MEASURED SURVEY AND D/17 FORM FILING

PLEASE SPECIFY THE DIMENSIONS, THE DOOR OPENING DIRECTION (LH OR RH) AND THE INSTALLATION TYPE (FREE-STANDING OR FLOOR LEVEL)

DISENIA[®]
ARCHITECTURAL SHOWERS

DISENIA S.R.L.
Via A. Carpenè, 21 - 33070 - Maron di Brugnera (PN)
Tel. +39 0434 613643 - Fax + 39 0422 742067
www.disenia.it ideagroup@ideagroup.it export@ideagroup.it

Date Model Dealer
Note Installer

**WE RECOMMEND ATTACHING
A PHOTO OF THE SHOWER SPACE**

LH EXT. OPENING DIRECTION

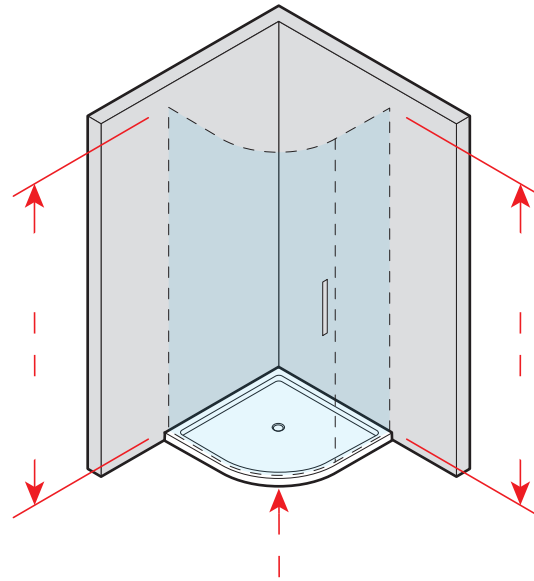
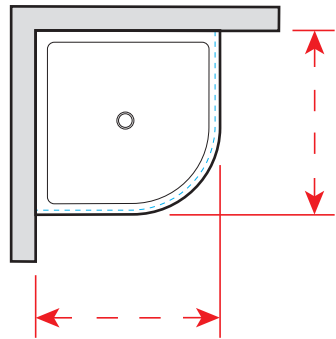

RH EXT. OPENING DIRECTION

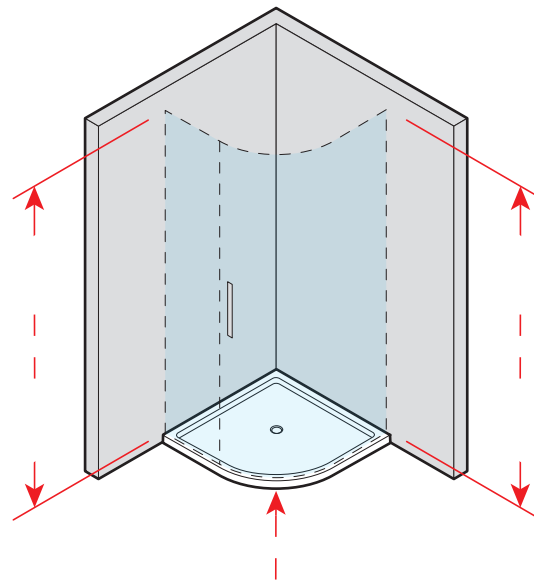
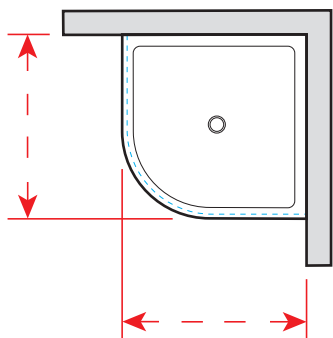

ON A TRAY

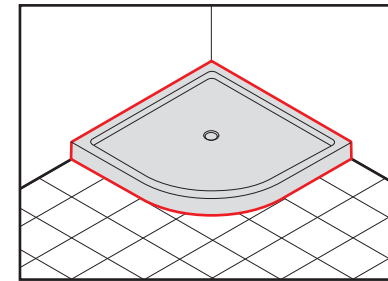

STANDARD INSTALLATION

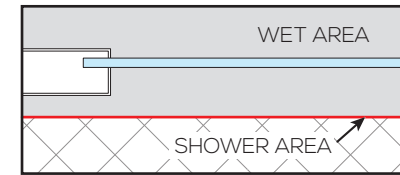

FLOOR LEVEL

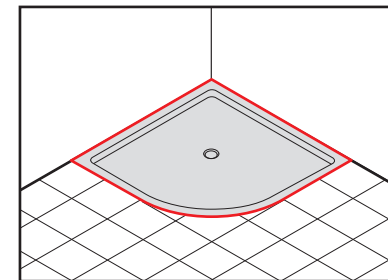

PROFILE INSTALLATION ON THE INSIDE



PROFILE INSTALLATION ON THE OUTSIDE



GLASS INSTALLATION ON THE INSIDE



GLASS INSTALLATION OUT OF THE GROUT LINE



GLASS INSTALLATION ON THE GROUT LINE

